



DOMOTICS
READY



APP
CONTROL



WIRELESS
REMOTE



CORDED
OPERATION



MANUAL
OPERATION

FOREST DECORATIVE ROD Series

Elegant and trendy rod systems. Available as manual, chain and motorised system.

CRS[®]
CRS[®] Deco
CRS[®] Corded
MRS[®] Motorised

THE WORLD
BEHIND
YOUR
CURTAINS



FOREST CURTAIN ROD SYSTEM - CRS®



PRODUCT INFORMATION

- Elegant and trendy hand drawn channel rod system
- Curtain rod fitted with curtain carriers
- Available in two dimensions: 20 mm (0,8") and 28 mm (1,1")
- Bendable, both with an inside and outside corner (except for Chrome)
- Available in 10 colours: White-PC, Anthracite-PC, Chrome, Inox-PC, Inox-AN, Gold, Bronze, Taupe-PC, Antique-PC and Black-PC
- The brackets and endcaps are available in matching colours
- Wide range of decorative finials offering great variety of design options
- Possibility to use without a finial for inside frame fix
- Length: 5,80 m (19")
- Rod quality: high-grade aluminium, powder coated or anodised
- Easy and quick assembly
- Forest Easyfold System (FES) for wave pleat also applicable on CRS

PROFILE

- Shown actual size 1:1
- Aluminium Extrusion
- Weight 20 mm (0,8"): 320 gram per meter
- Weight 28 mm (1,1"): 460 gram per meter
- Dimensions: 20 mm (0,8") and 28 mm (1,1")

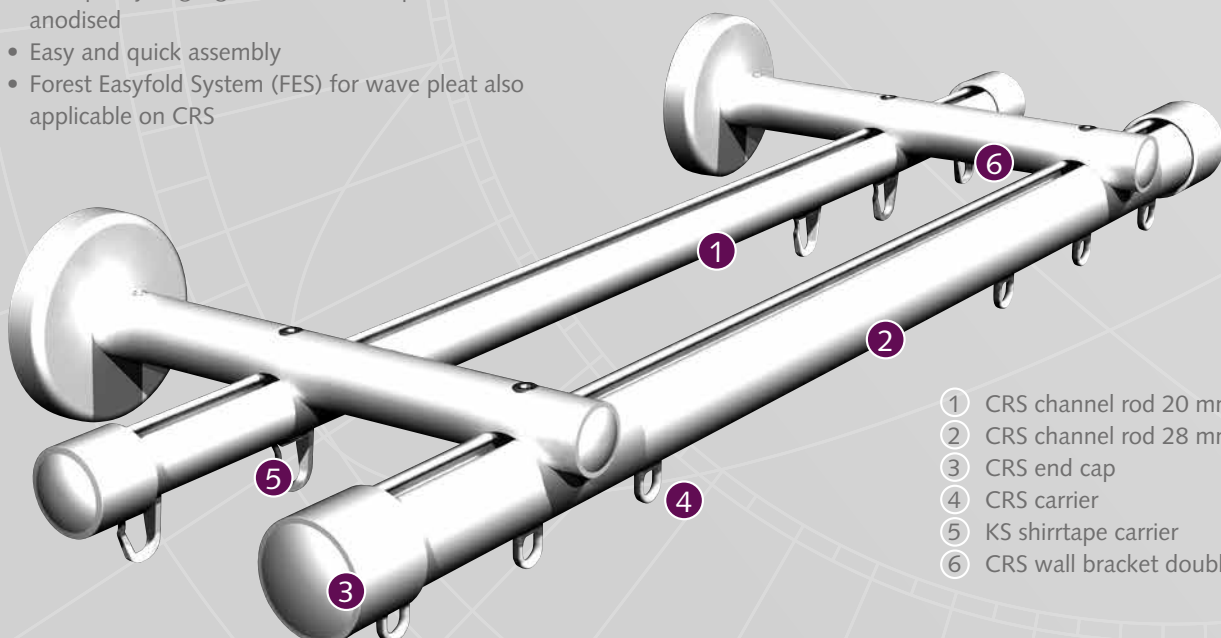
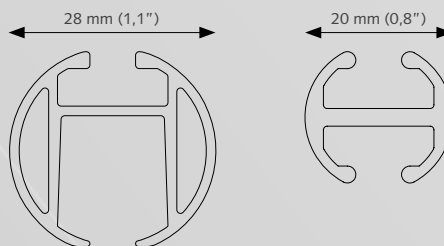

- 1 CRS channel rod 20 mm (0,8")
- 2 CRS channel rod 28 mm (1,1")
- 3 CRS end cap
- 4 CRS carrier
- 5 KS shirrtape carrier
- 6 CRS wall bracket double



MOUNTING BRACKETS

CRS Ceiling Bracket

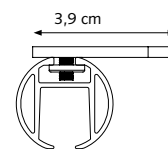

CRS Ceiling Suspension Bracket

4 cm (1,6"), 5 cm (2") or 10 cm (4")

20 mm (0,8")/ 28 mm (1,1").

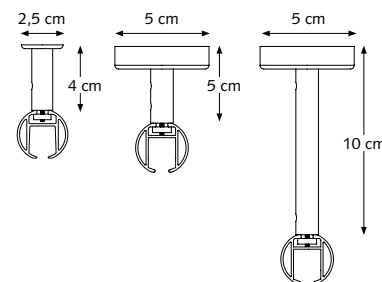

CRS Wall Bracket, single

8 cm (3,1") Ø 20 (0,8") or 28 mm (1,1").

12 cm (4,7") Ø 20 (0,8") or 28 mm (1,1").

16 cm (6,3") Ø 20 (0,8") or 28 mm (1,1").

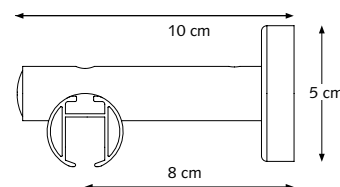

CRS Wall Bracket, double

16 cm (6,3") Ø 20 mm (0,8")

16 cm (6,3") Ø 28 mm (1,1")

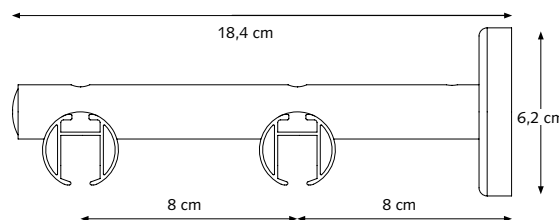

CRS Wall Bracket, double

16 cm (6,3") Ø 20/28 mm (0,8/1,1")

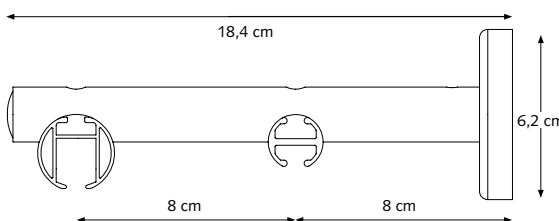

CRS Wall Bracket, double

20 cm (7,87") Ø 28 mm (1,1")

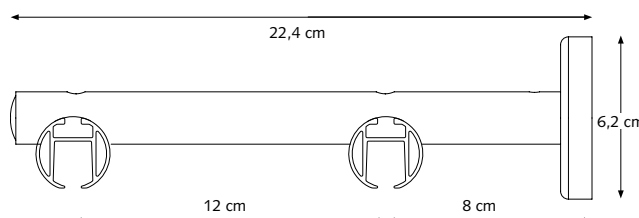

APPLICATIONS

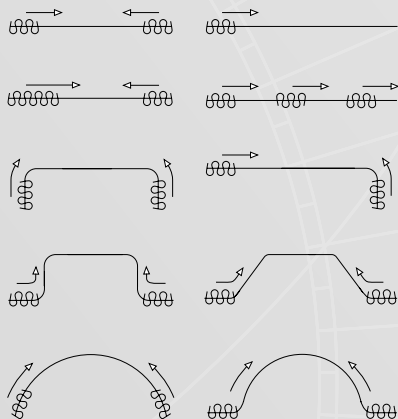

BENDING / CURVING

The 20 mm (0,8") rod can be bent and reverse bent using a radius of 10 cm (4"); the 28 mm (1,1") rod can be bent and reverse bent by using a radius of 20 cm (8").



FOR USE IN

Domestic and / or project market, or at any location where a high quality, elegant and manually operated channel rod system is requested.

FOREST CRS® Deco



PRODUCT INFORMATION

- Elegant and decorative hand drawn channel rod system
- Curtain rod fitted with eyelets and rings
- Equipped with special inlay for smooth operation and noise reduction
- Available in two dimensions: 20 mm (0,8") and 28 mm (1,1")
- Available in 5 colours: Anthracite-PC, Chrome, Inox-AN, Taupe-PC, Antique-PC
- The brackets and decorative endcaps are available in matching colours
- Wide range of decorative finials offering great variety of design options
- Possibility to use without a finial for inside frame fix
- Length: 5,80 m (19")
- Rod quality: high-grade aluminium, powder coated or anodised
- Easy and quick assembly
- The CRS Deco cannot be bent

PROFILE

- Shown actual size 1:1
- Aluminium Extrusion
- Track Ø 20 mm (0,8"): Maximum 3 kilograms at a support distance of 1.5 meters.
- Track Ø 28 mm (1,1"): Up to 4 kilograms at a support distance of 2.5 meters.
- Dimensions: 20 mm (0,8") and 28 mm (1,1")

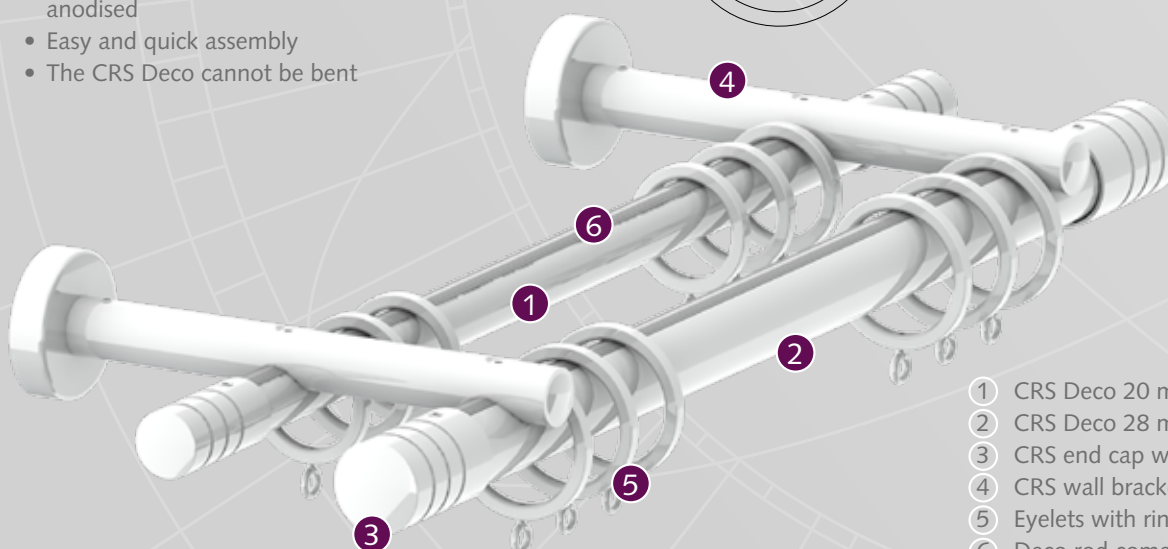
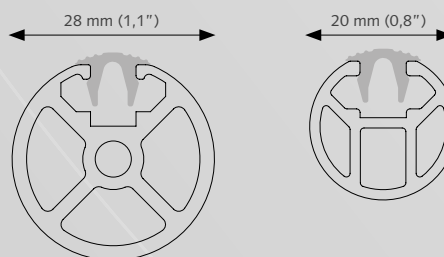

- 1 CRS Deco 20 mm (0,8")
- 2 CRS Deco 28 mm (1,1")
- 3 CRS end cap with 3 grooves
- 4 CRS wall bracket double
- 5 Eyelets with rings
- 6 Deco rod comes with a special inlay on top.



MOUNTING BRACKETS

CRS Ceiling Suspension Bracket

4 cm (1,6"), 5 cm (2") or 10 cm (4").

20 mm (0,8")/ 28 mm (1,1").

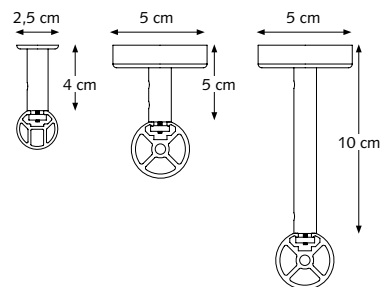

CRS Wall Bracket, single

8 cm (3,1") Ø 20 (0,8") or 28 mm (1,1").

12 cm (4,7") Ø 20 (0,8") or 28 mm (1,1").

16 cm (6,3") Ø 20 (0,8") or 28 mm (1,1").

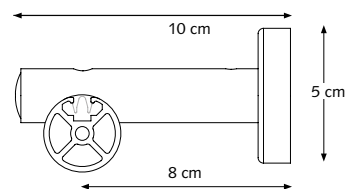

CRS Wall Bracket, double

16 cm (6,3") Ø 20 mm (0,8")

16 cm (6,3") Ø 28 mm (1,1")

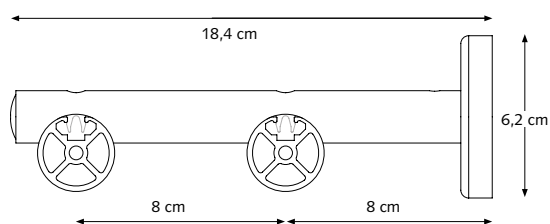

CRS Wall Bracket, double

16 cm (6,3") Ø 20/28 mm (0,8/1,1")

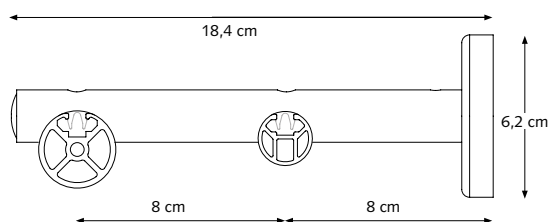

CRS Wall Bracket, double

20 cm (7,87") Ø 28 mm (1,1")

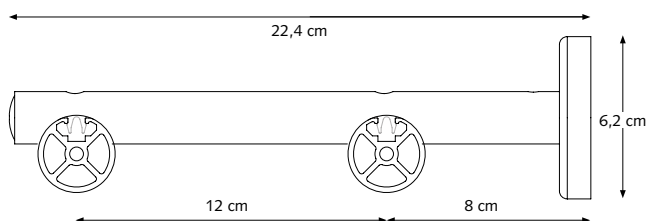

APPLICATIONS



SMOOTH AND SILENT OPERATION



Equipped with special inlay on top of rod for smooth operation and noise reduction.

FOR USE IN

Domestic and / or project market, or at any location where a high quality, elegant and manually operated channel rod system is requested.

SELECT YOUR FINIAL

Our large range of decorative finials offers you a great variety of design options. But is also possible to use without finial.



FOREST CRS® Corded



PRODUCT INFORMATION

- Elegant and trendy cord-operated channel rod system
- Curtain rod fitted with curtain carriers
- Available dimension: 28 mm (1,1")
- Bendable, both with an inside and outside corner (except for Chrome)
- Available in 7 colours: White-PC, Anthracite-PC, Chrome, Inox-AN, Taupe-PC, Antique-PC, Gold-AN
- The brackets and endcaps are available in matching colours
- Wide range of decorative finials offering great variety of design options
- Length: 5,80 m (19")
- Rod quality: high-grade aluminium, powder coated or anodised
- Easy and quick assembly
- Forest Easyfold System (FES) for wave pleat also applicable on CRS Corded
- Dual cord available

PROFILE

- Shown actual size 1:1
- Weight per meter: 8 kg and max weight load: 50 kg
- Aluminium extrusion
- Dimension: 28 mm (1,1")

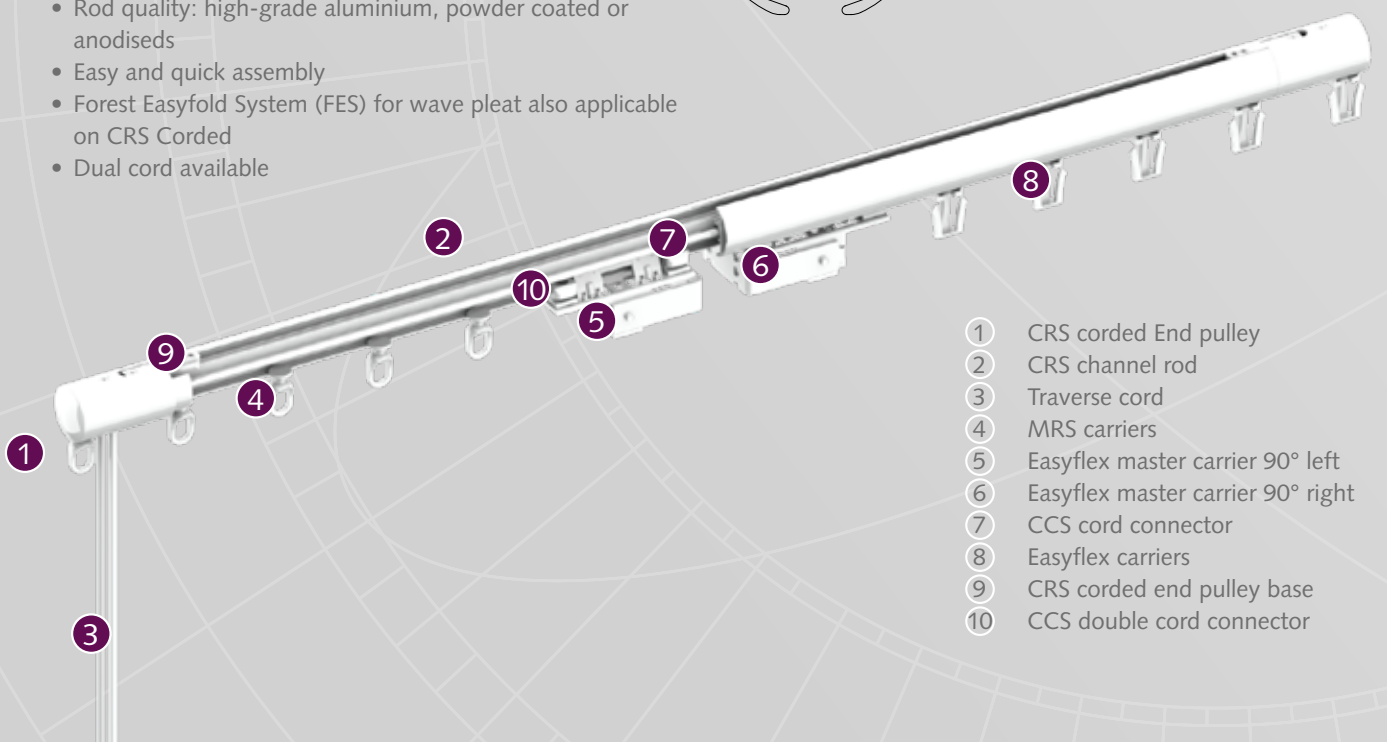
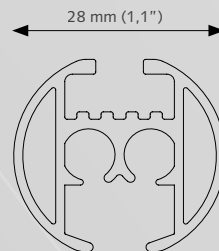

- 1 CRS corded End pulley
- 2 CRS channel rod
- 3 Traverse cord
- 4 MRS carriers
- 5 Easyflex master carrier 90° left
- 6 Easyflex master carrier 90° right
- 7 CCS cord connector
- 8 Easyflex carriers
- 9 CRS corded end pulley base
- 10 CCS double cord connector



MOUNTING BRACKETS

CRS Ceiling Bracket

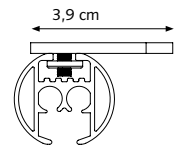

CRS Ceiling Support

4 cm (1,6"), 5 cm (2") or 10 cm (4").
20 mm (0,8")/ 28 mm (1,1").

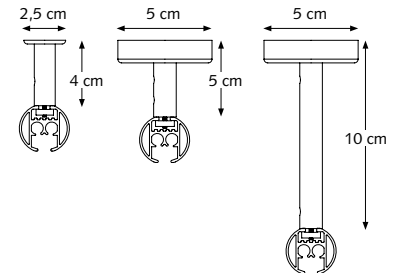

CRS Wall Bracket, single

8 cm (3,1"), 12 cm (4,7") and 16 cm (6,3")
(Base plate for the 12 cm (4,7") and 16 cm bracket is 6,2 cm (2,4"), similar to the double wall brackets.)

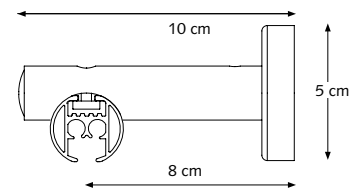

CRS Wall Bracket, double

16 cm (6,3")

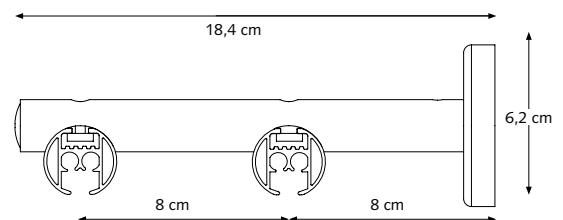

CRS Wall Bracket, double

16 cm (6,3") Ø 20 mm (0,8") (manual) / 28 mm (1,1") (corded)

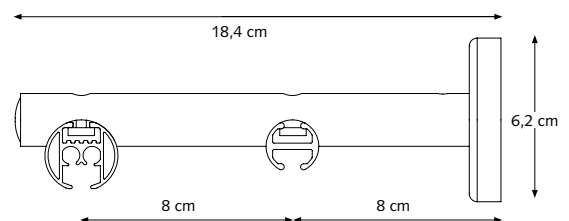

CRS Wall Bracket, double

20 cm (7,87") Ø 28 mm (1,1")

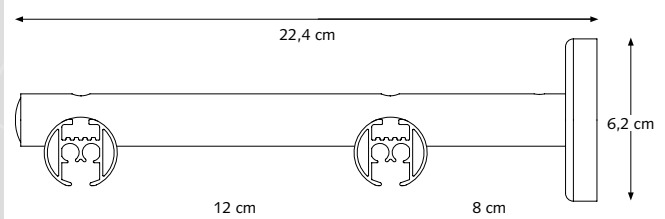

APPLICATIONS



Cross-Section Channel Rod with cord connectors and carriers.

BENDING / CURVING

The 28 mm (1,1") rod can be curved and reverse curved by using a radius of 20 cm (8").

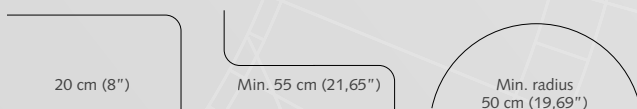

FOR USE IN

Domestic and / or contract market, or at any location where a high quality, elegant and corded operated channel rod system is required.

FOREST MOTORISED ROD SYSTEM - MRS®



PRODUCT INFORMATION

- Comfortable and luxurious motorised channel rod system
- Curtain rod fitted with curtain carriers
- Two types of motors available:
 - 24 Volt Forest Shuttle with touch impulse
 - 230 Volt FMS with 30, 45 or 60 Watt
- Available dimension: 28 mm (1,1")
- Available in 8 colours: White-PC, Anthracite-PC, Chrome*, Inox-PC, Inox-AN, Gold, Taupe-PC, Antique-PC
- The brackets and endcaps are available in matching colours
- Wide range of decorative finials offering great variety of design options
- Length: 5,80 m (19")
- Rod quality: high-grade aluminium, powder coated or anodised
- Easy-running return pulley
- Smooth and silent operation through Kevlar reinforcement of the transport belt
- Long life-span
- New MRS has an improved motor pulley. Creates a perfectly even pleat across the motor.
- New MRS has a new return pulley that allows the curtain to travel all way to the end
- Both motor pulley and return pulley of the new MRS can be reversibly installed, left or right.
- Domotica/Building Automation Ready
- Overlap carriers guarantees a complete closing of the curtains
- Forest Wave System for wave pleat also applicable on MRS
- Unique warranty: 10 year
- The MRS cannot be bent



3

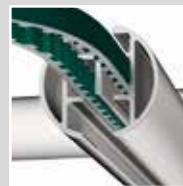

6



7

- 1 MRS channel rod
- 2 MRS end cap
- 3 MRS motor pulley equipped with high-quality ball bearings
- 4 Square Easy wave carrier
- 5 Wave adjustable master carrier
- 6 Kevlar transport belt
- 7 Easy running return pulley

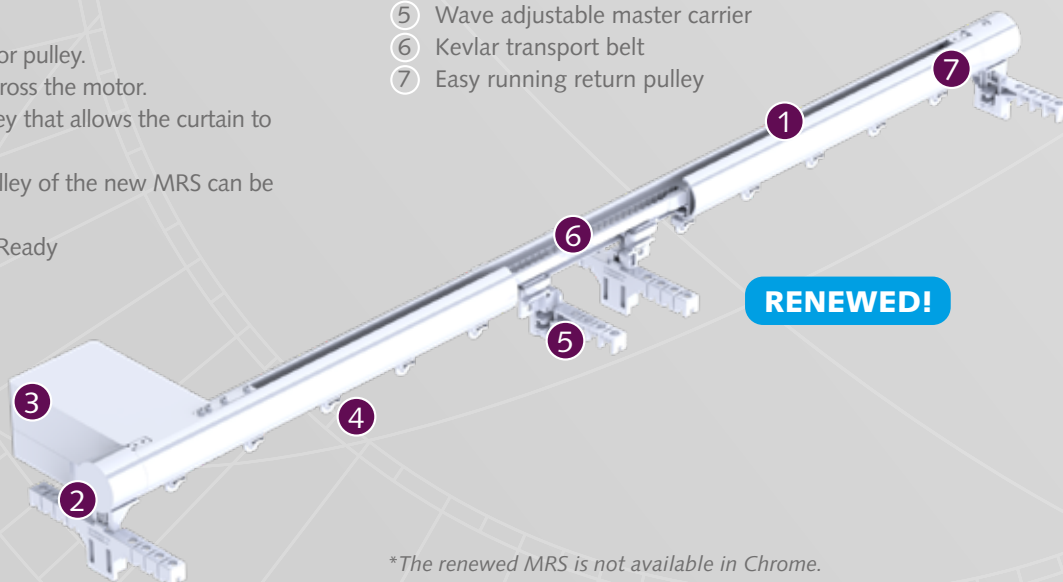

*The renewed MRS is not available in Chrome.



MOUNTING BRACKETS

MRS Ceiling Bracket

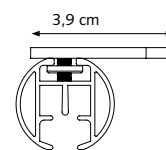

CRS/MRS Ceiling Suspension Bracket

4 cm (1,6"), 5* cm (2") or 10 cm (4")
20 mm (0,8")/ 28 mm (1,1").

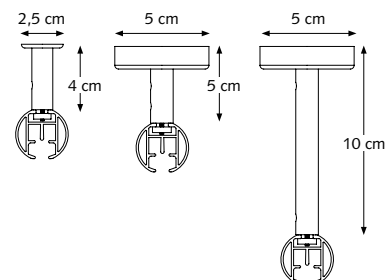

CRS/MRS Wall Bracket, single

12 cm (4,7") Ø 28 mm (1,1").
16 cm (6,3") Ø 28 mm (1,1").

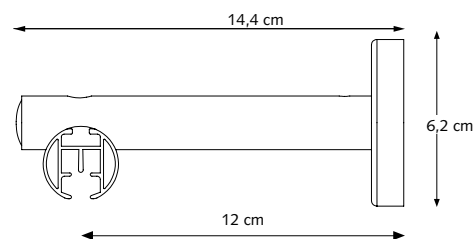

CRS/MRS Wall Bracket, double with 4 cm wall bracket extension

16 cm (6,3") Ø 28 mm (1,1")

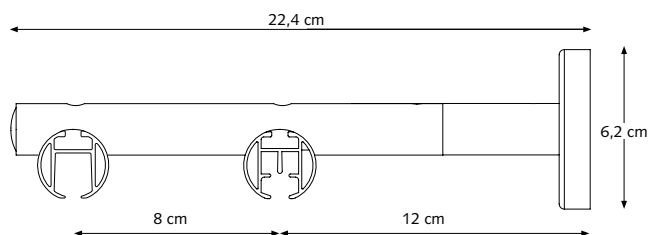

CRS/MRS Wall Bracket, double

20 cm (7,87") Ø 28 mm (1,1")

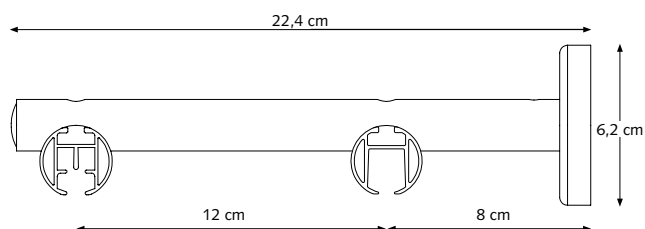

PROFILE

- Shown actual size 1:1
- Weight 480 gr/mtr
- Aluminium Extrusion
- Dimension: 28 mm (1,1")

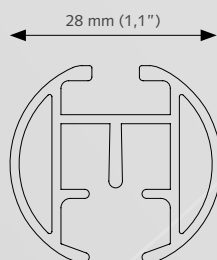

APPLICATIONS



FOR USE IN

Domestic and / or contract market, or at any location where a high quality, elegant and motorised operated channel rod system is required.

FOREST MOTORISED ROD SYSTEM - MRS®

Our wide range of controls make finding a fit for your home even easier; controlling the curtains by hand, remote or even by building automation system. With the remote you can control the curtains in any position you like. When controlling the motorised curtain system by your smartphone or tablet, you can create and schedule customised room scenes that allow your curtains to operate on their own throughout the day.



FOREST DIAMOND SENSE REMOTE

15 or 2 Channel Remote control. Control up to 15 systems individually and in group by integrated timer function or manual. Auto-On mode, when holding hand above it, the integrated LED light will automatically come on. Radio control, range up to 30 meters. Including magnetic wall support.



FOREST CONNECT

FOREST WI-FI DONGLE

With the Shuttle® Wi-Fi dongle, you can control your motorised curtains on your mobile device via the Forest Connect app or even by voice command with the easy integration in for example Google Home, Amazon Echo or Apple Siri without the need for an additional hub or gateway.



FOREST WIRELESS CONNECTOR

The Forest Wireless Connector is an easy way to make the motorised curtain systems 'smart'. This wireless remote solution works in combination with an analogue timer or a smart plug such as services as Apple HomeKit or Google Assistant or Amazon Alexa become available. With the Forest Smart Plug it is possible to control by the Forest Connect app. The Wireless Connector is also easily incorporated into most popular building management systems, including dry contact controls.



BUILDING AUTOMATION / HOTEL CONTROL

The Forest Shuttle® can be connected to any Building Automation system, by relay control.

SMART DEVICE CONNECTIVITY



Configure the right motorised curtain track system in a few steps.

	Shuttle S/M/L	Shuttle S/M/L with Z-Wave	Shuttle iOn	Shuttle AC	Forest Connect app	Google Home	Apple Homekit	Amazon Alexa	Google Assistant	Apple Siri	Voice control
Forest Wireless Connector One way transmitter to control curtains by third party apps or by Domotics. (433Mhz)	●		●		● ¹	● ¹	● ²	● ¹	● ¹	● ¹	● ¹
Forest Wi-Fi Dongle in combination with Forest Connect app	●	●			●	●		●	●	●	
Smartwares Controller in combination with HomeWizard lite app (433 Mhz)	●		●					●			
Homey in combination with Homey app	●	●	●			●	●	●	●	●	
FIBARO System in combination with FIBARO Home Center app		●		● ³		●	●	●	●	●	
Samsung SmartThings Hub in combination with Samsung SmartThings app		●				●	●	●	●	●	
230 Volt hard-wired building management system	● ⁴			●							









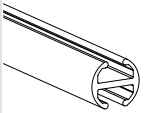
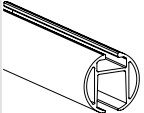
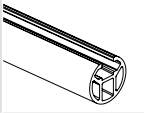
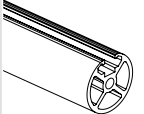
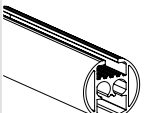
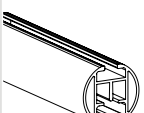

- 1) In combination with Forest smart plug
- 2) In combination with Apple Homekit smart plug
- 3) Only with FIBARO Roller Shutter 3 / Walli Roller Shutter
- 4) In combination with an AC Control Set





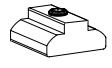
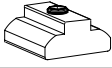





FOREST® MRS WORKS WITH

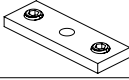



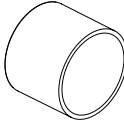
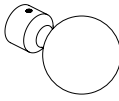
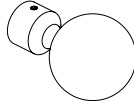

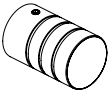

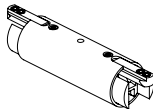

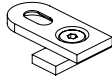
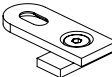
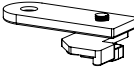

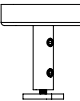
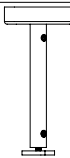
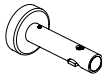
* Only works with actor.

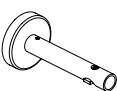
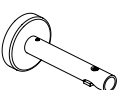
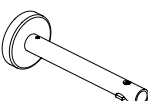
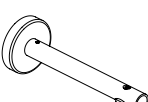
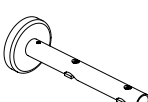

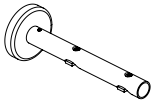
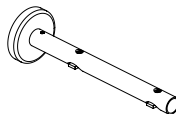
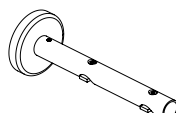
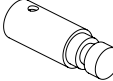
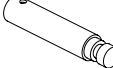



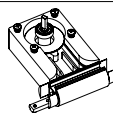

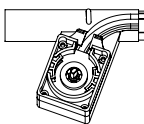
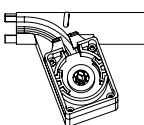

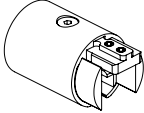
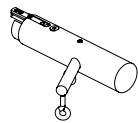
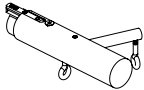

MRS® is compatible with many other Building Automation systems, thanks to its modular construction. A competitive advantage over other motorised drapery systems in the world!

CRS 20 mm	CRS 28 mm	CRS DECO 20	CRS DECO 28	CRS CORDED	MRS	ARTICLE	PACKING UNIT		ART.NR
●						 CRS CHANNEL ROD Ø 20 MM (0,8") Extruded aluminium, chromated, powder coated	5.80 mtr/tube	white-pc gold inox-an inox-pc taupe-pc bronze black-pc antique-pc anthracite-pc chrome	5801201580-PC 5801202580 5801203580 5801203580-PC 5801204580-PC 5801204580 5801206580-PC 5801209580-PC 5801205580-PC 5801207580
	●					 CRS CHANNEL ROD Ø 28 MM (1.1") Extruded aluminium, chromated, powder coated	5.80 mtr/tube	white-pc gold inox-an inox-pc bronze-an black-pc antique-pc anthracite-pc taupe-pc chrome	5801281580-PC 5801282580 5801283580 5801283580-PC 5801284580 5801286580-PC 5801289580-PC 5801285580-PC 5801284580-PC 5801287580
		●				 CRS DECO ROD Ø 20 MM (0.8") Extruded aluminium, chromated, powder coated	5.80 mtr/tube	inox-an antique-pc taupe-pc anthracite-pc chrome	5841203580 5841209580-PC 5841204580-PC 5841205580-PC 5841207580
			●			 CRS DECO ROD Ø28 MM (1.1") Extruded aluminium, chromated, powder coated incl. inlay strip	5.80 mtr/tube	inox-an inox-pc antique-pc taupe-pc anthracite-pc chrome	5841283580 5841283580-PC 5841289580-PC 5841284580-PC 5841285580-PC 5841287580
				●		 CRS CHANNEL ROD CORDED Ø 28 MM (1.1") Extruded aluminium, chromated, powder coated incl. inlay strip	5.80 mtr/tube	white-pc gold inox-an inox-pc antique-pc taupe-pc anthracite-pc chrome	5811281580-PC 5811282580 5811283580 5811283580-PC 5811289580-PC 5811284580-PC 5811286580-PC 5701287520
					●	 MRS MOTORISED ROD Ø28 MM (1.1") Extruded aluminium, chromated, powder coated	5.80 mtr/tube	white-pc gold inox-an inox-pc antique-pc taupe-pc anthracite-pc chrome	5701281580-PC 5701282580 5701283580 5701283580-PC 5701289580-PC 5701284580-PC 5701286580-PC 5701287520
●	●			●		 CRS CARRIER ROUND	500/box	white grey black	5810101000 5810103000 5810106000
					●	 MRS CARRIER ROUND	500/box	white grey black	5710101000 5710103000 5710106000
	●					 CS BALL BEARING (SMALL) carrier 16 mm for 28 mm CRS manual	100/box	white black	2512000016 2512006016
	●					 CONTRACT ROLLER CARRIER For a silent and smoothly operation with heavier curtains. Designed for use with butterfly pleats.	100/box	white black	4831001000 4831006000
		●				 CRS DECO CURTAIN RING FOR 20 MM	50/box	inox-an inox-pc taupe-pc anthracite-pc chrome antique-pc	5841203000 5841203000-PC 5841204000-PC 5841205000-PC 5841207000 5841209000-PC
			●			 CRS DECO CURTAIN RING FOR 28 MM	50/box	inox-an inox-pc taupe-pc anthracite-pc chrome antique-pc	5841283000 5841283000-PC 5841284000-PC 5841285000-PC 5841287000 5841289000-PC
●				●		 CRS METAL ENDSTOP WITH SCREW for 20 mm (0,8")	2/box		5816101000
	●			●		 CRS METAL ENDSTOP WITH SCREW for 28 mm (1.1")	100/box		5816101001
●						 CRS METAL ENDSTOP WITH SCREW-EYE for 20 mm (0,8")	100/box		5816102000
	●					 CRS METAL ENDSTOP WITH SCREW-EYE for 28 mm (1.1") long	100/box		5816102001
●						 CRS METAL ENDSTOP WITH SCREW-EYE for 20 mm (1.1") long	100/box		5816102002

CRS 20 mm	CRS 28 mm	CRS DECO 20	CRS DECO 28	CRS CORDED	MRS	ARTICLE	PACKING UNIT		ART.NR
●	●				●	 ENDSTOP UNIVERSAL METAL	100/box	white matt black matt	8880001000 8880006000
●	●			●		 CRS RAIL CONNECTOR (6 CM)	25/box		5815200006
		●	●		●	 CRS DECO / MRS / FMS PLUS TRACK CONNECTOR (20/28 MM)	25/box		5815200005
●	●	●	●	●		 CRS CORNER CONNECTOR (5 CM)	10/box		5815200007
●		●				 CRS FINIAL SHORT ENDCAP Ø 20 MM	10/box	white-pc gold inox-an inox-pc taupe-pc anthracite-pc black-pc chrome antique-pc	5816101220-PC 5816102220 5816103220 5816103220-PC 5816104220-PC 5816105220-PC 5816106220-PC 5816107220 5816109220-PC
	●		●			 CRS FINIAL SHORT ENDCAP Ø 28 MM	10/box	white-pc inox-an inox-pc taupe-pc anthracite-pc black-pc antique-pc	5816101228-PC 5816103228 5816103228-PC 5816104228-PC 5816105228-PC 5816106228-PC 5816109228-PC
●		●				 CRS FINIAL Ø 20 MM	10/box	white-pc gold inox-an inox-pc black-pc antique-pc taupe-pc anthracite-pc chrome	5816101020-PC 5816102020 5816103020 5816103020-PC 5816106020-PC 5816109020-PC 5816104020-PC 5816105020-PC 5816107020
	●		●	●		 CRS FINIAL Ø 28 MM	10/box	white-pc gold inox-an inox-pc black-pc antique-pc taupe-pc anthracite-pc chrome	5816101028-PC 5816102028 5816103028 5816103028-PC 5816106028-PC 5816109028-PC 5816104028-PC 5816105028-PC 5816107028
	●		●	●	●	 CRS/MRS FINIAL ROUND 60 MM 28 mm	2/box	white-pc gold inox-an inox-pc black-pc antique-pc taupe-pc anthracite-pc chrome	5716101100-PC 5716102100 5716103100 5716103100-PC 5716106100-PC 5716109100-PC 5716104100-PC 5716105100-PC 5716107100
	●		●	●	●	 CRS/MRS FINIAL ROUND 70 MM 28 mm	2/box	gold inox-an inox-pc antique-pc taupe-pc anthracite-pc chrome	5716102000 5716103000 5716103000-PC 5716109000-PC 5716104000-PC 5716105000-PC 5716107000
	●		●	●	●	 CRS FINIAL WITH 3 GROOVES 20 mm	2/box	inox-an anthracite-pc chrome	5816103120 5816105120-PC 5816107220
●		●				 CRS/MRS FINIAL WITH 3 GROOVES 28 mm	2/box	gold inox-an inox-pc black-pc antique-pc taupe-pc anthracite-pc chrome	5816102128 5816103128 5816103128-PC 5816106128-PC 5816109128-PC 5816104128-PC 5816105128-PC 5816107128
				●		 CRS CORDED END PULLEY complete	2/box	white-pc gold inox-an inox-pc antique-pc taupe-pc anthracite-pc	6130201001-PC 6130202001 6130203001 6130203001-PC 6130209001-PC 6130204001-PC 6130206001-PC
				●		 CRS CORDED CENTRE PULLEY complete	2/box	white-pc inox-an inox-pc antique-pc taupe-pc anthracite-pc	6130251001-PC 6130253001 6130253001-PC 6130259001-PC 6130254001-PC 6130256001-PC

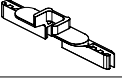

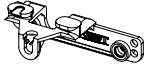
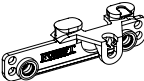
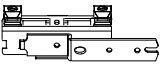

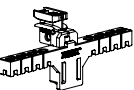
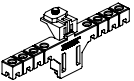
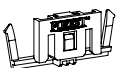





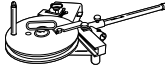

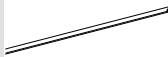

CRS 20 mm	CRS 28 mm	CRS DECO 20	CRS DECO 28	CRS CORDED	MRS	ARTICLE	PACKING UNIT		ART.NR
●	●			●	●	 CRS CEILING BRACKET SHORT Ø 20 MM with hole	100/box	white grey black	5818001000 5818001003 5818006000
						 CRS CEILING BRACKET LONG Ø 28 MM with hole		white grey anthracite black	5818003101-LA 5818003103-LA 5818009103-LA 5818006103-LA
	●			●		 CRS SWIVEL FOR 28 MM ROD	100/box		5863001000
●	●	●	●	●	●	 CRS CEILING SUSPENSION BRACKET 4 CM (1.57") Ø 20/28 mm	2/box	white-pc gold inox-an inox-pc taupe-pc black-pc antique-pc anthracite-pc chrome	5818112000-PC 5818122000 5818132000 5818132000-PC 5818142000-PC 5818162000-PC 5818192000-PC 5818152000-PC 5818172000
●	●	●	●	●	●	 CRS CEILING SUSPENSION BRACKET 5 CM (1.96") Ø 20/28 mm	2/box	white-pc gold inox-an inox-pc antique-pc	5818112028-PC 5818122028 5818132028 5818132028-PC 5818192028-PC
●	●	●	●	●	●	 CRS CEILING SUSPENSION BRACKET 10 CM (3.93") Ø 20/28 mm	2/box	white gold inox-an inox-pc black-pc antique-pc anthracite-pc	5818012028 5818022028 5818032028 5818032028-PC 5818062028-PC 5818092028-PC 5818052028-PC
●		●				 CRS WALL BRACKET SINGLE 8 CM (3.15") Ø 20 mm	2/box	white-pc gold inox-an inox-pc black-pc antique-pc anthracite-pc chrome	5820080120-PC 5820080220 5820080320 5820080320-PC 5820080620-PC 5820080920-PC 5820080520-PC 5820080720
	●		●	●		 CRS WALL BRACKET SINGLE 8 CM (3.15") Ø 28 mm	2/box	white-pc gold inox-an inox-pc black-pc antique-pc taupe-pc anthracite-pc chrome	5820080128-PC 5820080228 5820080328 5820080328-PC 5820080628-PC 5820080928-PC 5820080428-PC 5820080528-PC 5820080728
●		●				 CRS WALL BRACKET SINGLE 12 CM (4.72") Ø 20 mm	2/box	white-pc gold inox-an inox-pc black-pc antique-pc anthracite-pc chrome	5820120120-PC 5820120220 5820120320 5820120320-PC 5820120620-PC 5820120920-PC 5820120520-PC 5820120720
	●		●	●	●	 CRS WALL BRACKET SINGLE 12 CM (4.72") Ø 28 mm	2/box	white-pc gold inox-an inox-pc black-pc antique-pc taupe-pc anthracite-pc chrome	5820120128-PC 5820120228 5820120328 5820120328-PC 5820120628-PC 5820120928-PC 5820120428-PC 5820120528-PC 5820120728
●		●				 CRS WALL BRACKET SINGLE 16 CM (6.29") Ø 20 mm	2/box	white-pc gold inox-an inox-pc black-pc antique-pc	5820160120-PC 5820160220 5820160320 5820160320-PC 5820160620-PC 5820160920-PC
	●		●	●	●	 CRS WALL BRACKET SINGLE 16 CM (6.29") Ø 28 mm	2/box	white-pc gold inox-an inox-pc black-pc antique-pc taupe-pc anthracite-pc	5820160128-PC 5820160228 5820160328 5820160328-PC 5820160628-PC 5820160928-PC 5820160428-PC 5820160528-PC
●		●				 CRS WALL BRACKET DOUBLE 16 CM (6.29") Ø 20 mm	2/box	white-pc gold inox-an inox-pc black-pc antique-pc chrome	5822160120-PC 5822160220 5822160320 5822160320-PC 5822160620-PC 5822160920-PC 5822160720

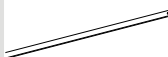
CRS 20 mm	CRS 28 mm	CRS DECO 20	CRS DECO 28	CRS CORDED	MRS	ARTICLE	PACKING UNIT		ART.NR
	●		●	●	●	 CRS WALL BRACKET DOUBLE 16 CM (6.29") Ø 28 mm	2/box	white-pc gold inox-an inox-pc black-pc antique-pc taupe-pc anthracite-pc	5822160128-PC 5822160228 5822160328 5822160328-PC 5822160628-PC 5822160928-PC 5822160428-PC 5822160528-PC
	●		●			 CRS WALL BRACKET DOUBLE 20 CM (7.87") Ø 28 mm	2/box	white-pc gold inox-an inox-pc black-pc antique-pc taupe-pc anthracite-pc chrome	5822200128-PC 5822200228 5822200328 5822200328-PC 5822200628-PC 5822200928-PC 5822200428-PC 5822200528-PC 5822200728
●	●					 CRS WALL BRACKET DOUBLE 16 CM (6.29") Ø 20/28 mm	2/box	white-pc gold inox-an inox-pc black-pc antique-pc	5822012028-PC 5822022028 5822032028 5822032028-PC 5822036028-PC 5822039028-PC
●	●			●	●	 CRS WALL BRACKET EXTENSION 4 CM	10/box	white-pc inox-an inox-pc black-pc taupe-pc antique-pc anthracite-pc	5815201030-PC 5815203030 5815203030-PC 5815206030-PC 5815204030-PC 5815209030-PC 5815205030-PC
●	●			●	●	 CRS WALL BRACKET EXTENSION 8 CM		inox-an black-pc antique-pc	5815103020 5815106020-PC 5815109020-PC
●	●			●	●	 CRS ADJUSTABLE BRACKET EXTENSION Adjustable 2-4 cm	10/box	white-pc gold inox-an inox-pc taupe-pc anthracite-pc black-pc antique-pc	5815101070-PC 5815102070 5815103070 5815103070-PC 5815104070-PC 5815105070-PC 5815106070-PC 5815109070-PC
●						 CRS INSIDE WALL BRACKET Ø 20 MM	10/box	white-pc gold inox-an inox-pc black-pc antique-pc	5817101020-PC 5817102020 5817103020 5817103020-PC 5817106020-PC 5817109020-PC
	●				●	 CRS INSIDE WALL BRACKET Ø 28 MM	10/box	white-pc gold inox-an inox-pc black-pc antique-pc taupe-pc anthracite-pc chrome	5817101028-PC 5817102028 5817103028 5817103028-PC 5817106028-PC 5817109028-PC 5817104028-PC 5817105028-PC 5817107028
					●	 MRS MOTOR PULLEY UNIVERSAL RENEWED!	1/box	white-pc inox-pc antique-pc taupe-pc anthracite-pc	5740101000-PC 5740108000-PC 5740109000-PC 5740104000-PC 5740105000-PC
					●	 MRS MOTOR PULLEY UNIVERSAL CAP SET RENEWED!	1/box	white grey black	5740101010 5740103010 5740106010
					●	 MRS MOTOR PULLEY UNIVERSAL FINIAL RENEWED!	1/box	white-pc inox-pc antique-pc taupe-pc anthracite-pc	5740111000-PC 5740118000-PC 5740119000-PC 5740114000-PC 5740115000-PC
					●	 MRS MOTOR PULLEY LEFT	1/box	white-pc gold inox-an inox-pc antique taupe-pc anthracite-pc chrome	5730101000-PC 5730102000 5730108000 5730108000-PC 5730109000-PC 5730104000-PC 5730106000-PC 5730107000
					●	 MRS MOTOR PULLEY RIGHT	1/box	white-pc gold inox-an inox-pc antique taupe-pc anthracite-pc chrome	5730201000-PC 5730202000 5730208000 5730208000-PC 5730209000-PC 5730204000-PC 5730206000-PC 5730207000

CRS 20 mm	CRS 28 mm	CRS DECO 20	CRS DECO 28	CRS CORDED	MRS	ARTICLE	PACKING UNIT		ART.NR
					●	 <p>MRS RETURN PULLEY UNIVERSAL VERNIEUWD!</p>	1/box	white-pc inox-pc antique-pc taupe-pc anthracite-pc	5740121000-PC 5740128000-PC 5740129000-PC 5740124000-PC 5740125000-PC
					●	 <p>MRS RETURN PULLEY LEFT</p>	1/box	white-pc gold inox-an inox-pc antique-pc taupe-pc anthracite-pc chrome	5730111000-PC 5730112000 5730118000 5730118000-PC 5730119000-PC 5730114000-PC 5730116000-PC 5730117000
					●	 <p>MRS RETURN PULLEY RIGHT</p>	1/box	white-pc gold inox-an inox-pc antique-pc taupe-pc anthracite-pc chrome	5730121000-PC 5730122000 5730128000 5730128000-PC 5730129000-PC 5730124000-PC 5730126000-PC 5730127000
				●		 <p>TRAVERSE CORD Polyester drapery cord designed for strong smooth slide, Ø 3.5 mm (0,14"), 16 ply. Suitable for CKS/CCS/CRS/DS-XL Corded</p>	250 mtr/roll	white grey black	1030401000 1030403000 1030406000
				●		 <p>CCS CORD CONNECTOR</p>	100/box	white grey black	3030301000 3030303000 3030306000
				●		 <p>CCS DOUBLE CORD CONNECTOR</p>	20/box	white grey black	3030301010 3030303010 3030306010
				●		 <p>ASSEMBLY TOOL FOR CKS/CCS/CRS CORD CONNECTOR</p>	Piece		9510000027
				●		 <p>CORD/CHAIN WEIGHT DESIGN</p>	10/box	white black grey	3030701000 3030706000 3030703000
				●		 <p>CKS / CCS TENSION PULLEY</p>	25/box		1030501000
				●		 <p>BS CORD / CHAIN WALL MOUNT SAFETY BOX SINGLE</p>	25/box		3645702000
				●		 <p>FMS TRANSPORT BELT</p>	100 Mtr/ roll		5105501000
				●		 <p>EASYFOLD MRS BELT CONNECTOR</p>	25/box		4805711500
●	●			●	●	 <p>EASYFOLD PLASTIC MASTER UNDERLAP</p>	25/box	white grey black transparent	4815201010 4815203010 4815206010 4815201000
●	●			●	●	 <p>EASYFOLD PLASTIC MASTER STRAIGHT/OVERLAP</p>	25/box	white grey black transparent	4815101010 4815103010 4815106010 4815101000
				●	●	 <p>FMS MASTER CARRIER UNDERLAP Multifunctional - arm is reversible for Click on stiffner</p>	15/box	white grey black	5215801010 5215803010 5215806010
				●	●	 <p>FMS MASTER CARRIER OVERLAP Multifunctional – arm is reversible for Click on stiffner</p>	15/box	white grey black	5215901010 5215903010 5215906010
				●		 <p>WAVE ADJUSTABLE MASTER CARRIER For use with wave pleat curtains (Easyflex)</p>	25/box	white black	4813001050 4813006050
	●			●		 <p>WAVE ADJUSTABLE ENDSTOP For use with wave pleat curtains (FES). Height adjustable and blocks detachable for the correct wave pleat depth</p>	25/box	white black	4816001001 4816006001
				●		 <p>WAVE ADJUSTABLE HOOK FOR MOTOR For use with wave pleat curtains (Easyflex) (only suitable for MRS motor pulley left & right)</p>	25/box	white black	4813001010 4813006010

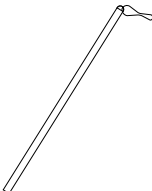
GO TO THE FES BROCHURE FOR OTHER FES (WAVE) ITEMS, SUCH AS CARRIERS, TAPE, AND HOOKS.

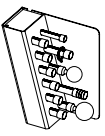

CRS 20 mm	CRS 28 mm	CRS DECO 20	CRS DECO 28	CRS CORDED	MRS	ARTICLE	PACKING UNIT	ART.NR
●	●					 CONTRACT BENDING TOOL, for Ø20 and Ø 28 mm (1.1") CRS	1/each	256000000
●						 CRS CONTRACT BENDING WHEEL ALL-IN Ø 20 cm (8"), for Ø 20 mm (0,8") CRS incl. strips	1/each	5860200020
	●					 CRS BENDING WHEEL Ø 40 cm (16"), for Ø 28 mm (1.1") CRS incl. strips	1/each	5860000028
●						 CRS BENDING STRIPS Ø 20 mm (0.8"), 60 cm (23.6")	1/each	5860100020
	●					 CRS BENDING STRIPS, Ø 28 mm (1.1"), 60 cm (23.6")	1/each	5860100028
●						 CRS Bending Strips, Ø 20 mm (0.8"), 7 m (275")	1/each	5860700020
	●					 CRS BENDING STRIPS, Ø 28 mm (1.1"), 7 m (275")	1/each	5860700028
	●					 BENDING STANDARD Standard for contract bending tool 28 mm (1,1")	1/each	2560800000
●	●					 ELECTRIC POWERED BENDER Available in 230V or 115V	1/each	1060500000
●	●					 SET CRS BENDING WHEELS Ø 20/28 mm (0,8/1,1")	1/set	5860702028
●	●	●	●	●	●	 CHANNEL ROD LUBRICANT SPRAY		5109020000
●	●	●	●			 DRAW STICK FIBERGLASS	100/box	92 cm 1065101092 122 cm 1065101122 152 cm 1065101152 202 cm 1065001202
						DRAW STICK TRANSPARENT	50/box	92 cm 1065102092 122 cm 1065102122 152 cm 1065102152
●	●	●	●			DRAW STICK ALUMINIUM WHITE	50/box	92 cm 1065111092 122 cm 1065111122 152 cm 1065111152 202 cm 1065111202
						DRAW STICK ALUMINIUM GREY	50/box	92 cm 1065113092 122 cm 1065113122 152 cm 1065113152
						DRAW STICK ALUMINIUM BLACK	50/box	92 cm 1065116092 122 cm 1065116122 152 cm 1065116152
						DRAW STICK ALUMINIUM ANTIQUE	50/box	92 cm 1065119092 122 cm 1065119122 152 cm 1065119152
●	●	●	●	●	●	 FOREST CRS/MRS COLOUR SAMPLER	1/each	9904100101
●	●	●	●	●	●	 DECORATIVE ROD DISPLAY including rods and colour sampler	1/set	9902000001
●	●	●	●	●	●	 FOREST ROD DEMO FLIGHTCASE The Rod Demo Case provides a comprehensive overview of our rod assortment, including CRS 20mm, CRS 28mm, CRS Deco 20mm, CRS Deco 28mm, CRS corded, and MRS.	1/each	9904000000



Scan the QR code for Shuttle motors and operating modes.